

# TravelScan Pro 300 Handheld Wand Scanner with



# User Guide

# TravelScan Pro 300 Handheld Wand Scanner User Guide

## Contents

- Box Contents** ..... 4
- Product Specifications**..... 4
- TravelScan Pro 300 Handheld Wand Scanner Functions** ..... 5
  - Top View** ..... 5
  - Bottom View** ..... 6
- Display Settings - Modes** ..... 6
  - Battery Powered** ..... 6
  - Connect USB for Power** ..... 6
  - Connect with PC** ..... 6
- Display Settings - Scanning** ..... 7
  - Setting the Menu**..... 7
  - Color Settings** ..... 8
  - Resolution Settings**..... 8
  - File Format Setting** ..... 8
  - DS Locked/Unlocked Setting**..... 8
- Format Setting for SD card**..... 9
- Time Setting**..... 9
- Checking/Deleting Pictures**..... 9
- Battery Powered Operation**..... 9
- Scanning While Connected to Computer** ..... 10
  - Accessing Images Directly from the SD Card** ..... 10
- Wand**..... 11
  - Save**..... 11
  - Delete**..... 11
  - Stitch** ..... 11
- Stitching** ..... 12
  - Scanning Vertically or Horizontally**..... 12
  - Using the Settings**..... 13
  - Stitching Images** ..... 14
  - Scanning With at Least 20% Overlap** ..... 14
  - Viewing Stitched Files** ..... 14
- Tagging**..... 15

# TravelScan Pro 300 Handheld Wand Scanner User Guide

<b>Search</b> .....	16
<b>My Scans</b> .....	17
<b>Viewing</b> .....	17
<b>Deleting</b> .....	17
<b>Renaming</b> .....	17
<b>Add/Edit/Delete Tags</b> .....	17
<b>Cloud</b> .....	18
<b>Settings Menu</b> .....	19
<b>Settings Functions</b> .....	20
<b>Advanced Settings</b> .....	21
<b>Advanced Settings Functions</b> .....	22
<b>Troubleshooting</b> .....	23
<b>Technical Support</b> .....	23

# TravelScan Pro 300 Handheld Wand Scanner User Guide

## Box Contents

1. TravelScan Pro 300 Handheld Wand Scanner
2. Hard shell case
3. USB cable
4. 3 AAA batteries
5. Pouch
6. Micro SD card

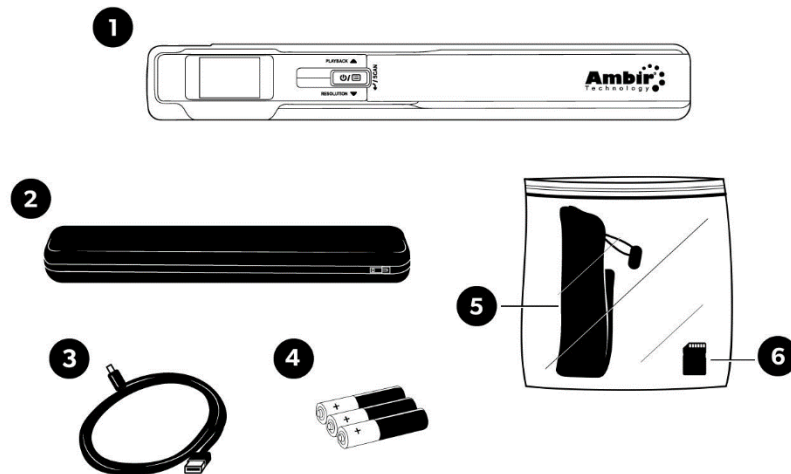

## Product Specifications

Dimensions	257x36x24 mm
Weight	153.7g
Sensor Type	CIS
Resolution	300 DPI (default, 600 DPI, 900 DPI)
Scan Width	216 mm
Scan Length	1200 mm
External Memory Card	Micro SD card (TF card) up to 32 GB
Output File Formats	JPEG/PDF
Display Panel	1.4" TFT LCD
Focus Range	Contact, 0.3 mm
USB Port	USB 2.0 high speed
Power Source	3 AAA batteries or USB
System Requirements	Windows 7/8/10

# TravelScan Pro 300 Handheld Wand Scanner User Guide

## TravelScan Pro 300 Handheld Wand Scanner Functions

### Top View

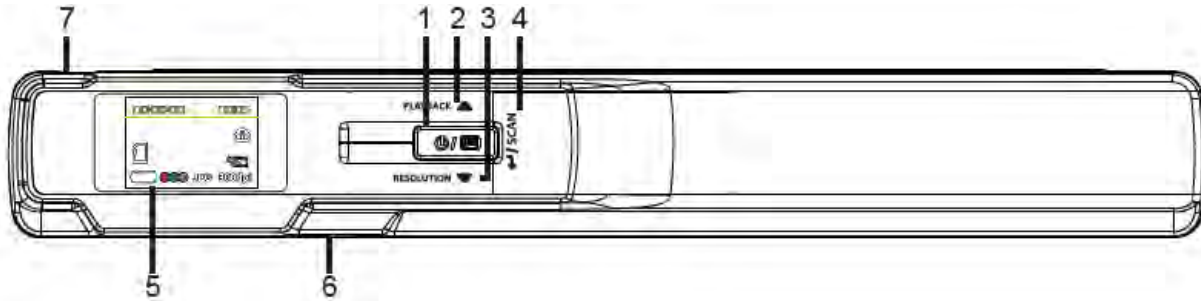

Number	Name	Function/Description
1	Power/Menu	<p><b>Power On:</b> Press and hold the Power button for 2 seconds to turn on.</p> <p><b>Power Off:</b> Press and hold the Power button for 2 seconds to turn off.</p> <p><b>Access the Menu:</b> Press the Menu button to access the menu.</p>
2	Up/Playback	<p><b>In Menu:</b> Scrolls up.</p> <p><b>In the Main Interface:</b> Checks picture.</p>
3	Down/Resolution	<p><b>In Menu:</b> Scrolls down.</p> <p><b>In the Main Interface:</b> Resolution section.</p>
4	Scan/Enter	<p><b>In Menu:</b> Press button to confirm selection.</p> <p><b>In the Main Interface:</b> Press to start/stop scanning.</p>
5	TFT Display	Displays all statuses of the scanner.
6	Micro SD Card Slot	Insert micro SD card.
7	USB Interface	<p>When USB cable is inserted and connected to the PC, it will scan and input directly to the PC.</p> <p>USB cable may also be used when battery power is low on the scanner.</p>

# TravelScan Pro 300 Handheld Wand Scanner User Guide

## Bottom View

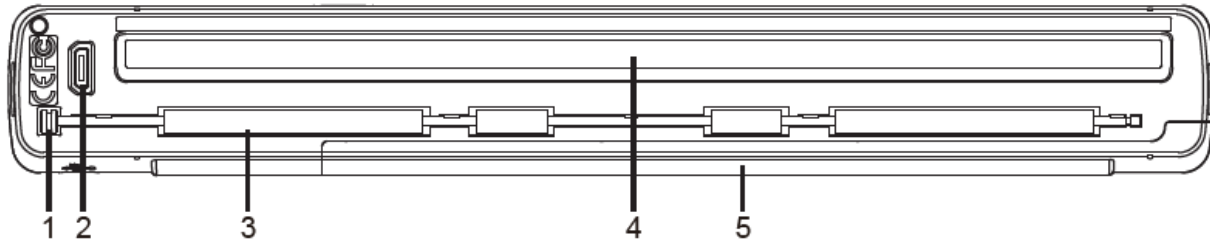

Number	Name	Function/Description
1	Front Roller	Transfer the rolling signal into scanner for internal processing.
2	Interface	Optional mount for docking.
3	Main Roller	Assists the scanner in scanning media through.
4	CIS Glass	Sensor for media being scanned.
5	Battery Cover	Slide to open. Scanner uses 3 AAA batteries for operation.  The scanner does not recharge batteries. Replace batteries when low on power.

## Display Settings - Modes

The TravelScan Pro 300 Handheld Wand Scanner has 3 working modes, as displayed below:

### Battery Powered

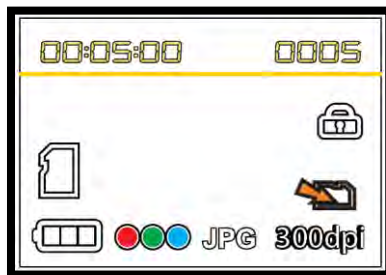

### Connect USB for Power

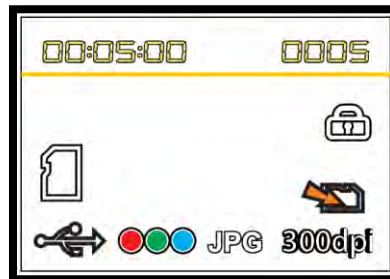

### Connect with PC

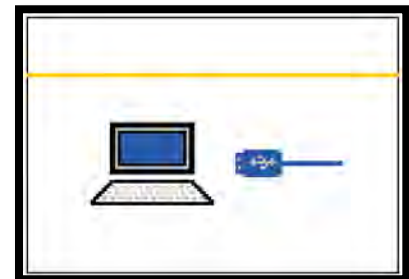

# TravelScan Pro 300 Handheld Wand Scanner User Guide

## Display Settings - Scanning

The following section includes information on the display of the TravelScan Pro 300 Handheld Wand Scanner.

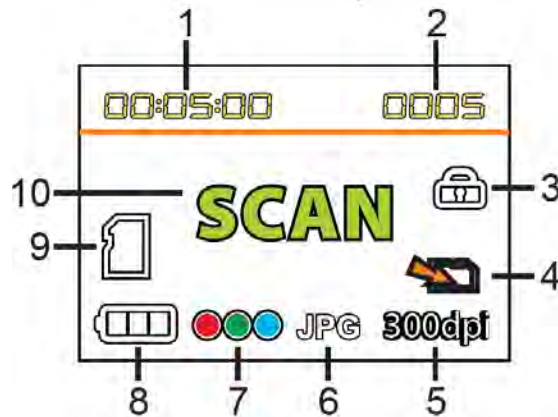









Number	Name	Description
1	Time	Shows setting time. (hour: minutes: seconds).
2	Scanning QTY	Shows the scanning QTY in the SD card.
3	SD Card Locked/Unlocked	Locked       Unlocked
4	Document Output Select	To select and output the scanned documents to SD card or PC.
5	Resolution	Resolution rate.
6	Format Select	Scanned file format.
7	Color Format	Scanning image is mono or color.
8	Battery Status	Battery status indicators: Full power       Half power Low power       Change battery
9	SD Card Status	SD card status indicators: 1. No signal means no SD card insert. 2. Signal  means SD insert. 3. Signal  means SD card is full.
10	Status Display	Showing scanning or connecting to the PC.

## Setting the Menu







1. Load the SD card and batteries and press the for 2 seconds to start.
2. Press button. In the TFT display, there is a main menu where you can:
  - a. Set color
  - b. Set resolution
  - c. JPG/PDF
  - d. Encrypt/not encrypt
  - e. Time
  - f. Format
3. Press or to choose the menu.
4. Press /SCAN to confirm, then enter the submenu option.
5. Press to exit the menu or pause about 5 seconds to return to the main interface.

# TravelScan Pro 300 Handheld Wand Scanner User Guide

## Color Settings







1. Press  to enter the Menu after scanner is powered on.
2. Choose  menu, then press /SCAN to choose the color option:
  - a. Color mode: 
  - b. Mono mode (black and white): 
3. Press  or  to select your option.
4. Press /SCAN to confirm the color mode and exit the submenu.

## Resolution Settings









1. Press  to enter the Menu after scanner is powered on.
2. Choose  menu.
3. Press /SCAN button and choose the resolution option:
  - a. 300 dpi
  - b. 600 dpi
  - c. 900 dpi
4. Press  or  to select your option.
5. Press /SCAN to confirm the resolution and exit the submenu.

**Note:** During Standby status, you can press  to select resolution directly.

## File Format Setting

1. Press  to enter the Menu after scanner is powered on.
2. Press  menu.
3. Press /SCAN to choose the File Format option:
  - a. JPG
  - b. PDF
4. Press  or  to select your option.
5. Press /SCAN to confirm your file selection and exit the submenu.

## DS Locked/Unlocked Setting





1. Press  to enter the Menu after scanner is powered on.
2. Select  menu.
3. Press /SCAN to choose the File Encryption menu.
  - a. Locked: 
  - b. Not Locked: 
4. Press  or  to select your option.
5. Press /SCAN to confirm your file selection and exit the submenu.

**Note:** File locking/unlocking can only work after SD card formatting. The file can read only if you put the SD card into the scanner and connect to the PC.









## Format Setting for SD card







**Important:** After formatting, all files on the SD card will be lost. Please be sure to save your images before formatting.

1. Press  to enter the Menu after scanner is powered on.
2. Select  menu.
3. Press  / SCAN to choose the Format menu.
  - a. Not formatted: 
  - b. Formatted: 

## Time Setting



1. Press  to enter the Menu after scanner is powered on.
2. Press  menu.
3. Press  / SCAN button to choose the time setting.
4. When YEAR/MONTH/DAY/HOUR/MINUTE displays in the upper right of the TFT screen, use the  or  buttons to adjust.
5. Press  / SCAN to confirm and enter the next time setting.

## Checking/Deleting Pictures

1. Select the picture you wish to delete on the scanner.
2. Press  / SCAN and you will see the following icons:
  - a. Select to Delete: 
  - b. Cancel Delete: 
3. Press  or  to select your option.
4. Press  button to exit the picture review.

## Battery Powered Operation

To operate your scanner using battery power only, follow the steps below:

1. Load the SD card and batteries on the scanner and press  for 2 seconds to open.
2. Set your required color, resolution, file format and locked/unlocked mode.
3. With the scanner on a flat surface, insert the document(s).
4. Press the  / SCAN button.
5. The display screen will show **SCAN** as the document(s) scan.
6. Hold the scanner and slide in the desired direction.
7. Press  / SCAN again to exit the scanning mode.

# TravelScan Pro 300 Handheld Wand Scanner User Guide

## Notes:

- Confirm the SD card is in the scanner.
- Do not remove the SD card before scanning is complete.
- Set the correct date and time on the scanner for accuracy of file management.
- If the scanning is too fast, you will see **ERROR** display in the window. Stop scanning and try again.
- During scanning, make sure you're scanning level to ensure quality images.

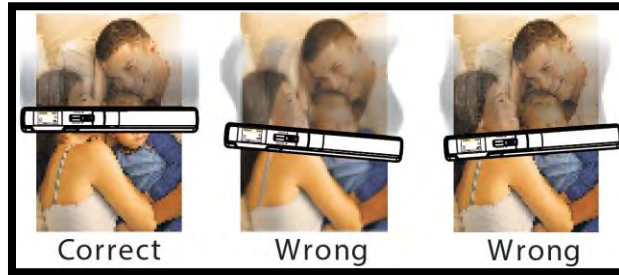





- Ensure the document is flat and in contact with the document to avoid tilts or gaps.



- Confirm there are no fingerprints/debris on the CIS glass as this will affect scanning quality.

## Scanning While Connected to Computer

To scan while connected via USB to a computer, complete the following steps:

1. Insert the SD card and plug in the USB cable.
2. Press  for 2 seconds. You will see  blinking in the lower portion of the display screen.
3. Press  or  to shift to  which represents the file being exported to the SD card.
4. Use scanner normally as described in the previous section.

## Accessing Images Directly from the SD Card

Images are stored in the following folder: D:\DCIM\100MEDIA. You can access this folder when your scanner is connected via USB to a computer or inserted into a SD card reader slot of a computer.

 **Images *must remain* in this folder to be viewed in AmbirScan and Stitching. Files moved out of this folder will *not* display in AmbirScan and will not be available for Stitching.**

## Wand

You can also access the images scanned with your TravelScan Pro 300 Handheld Wand Scanner in AmbirScan from the Wand tab.

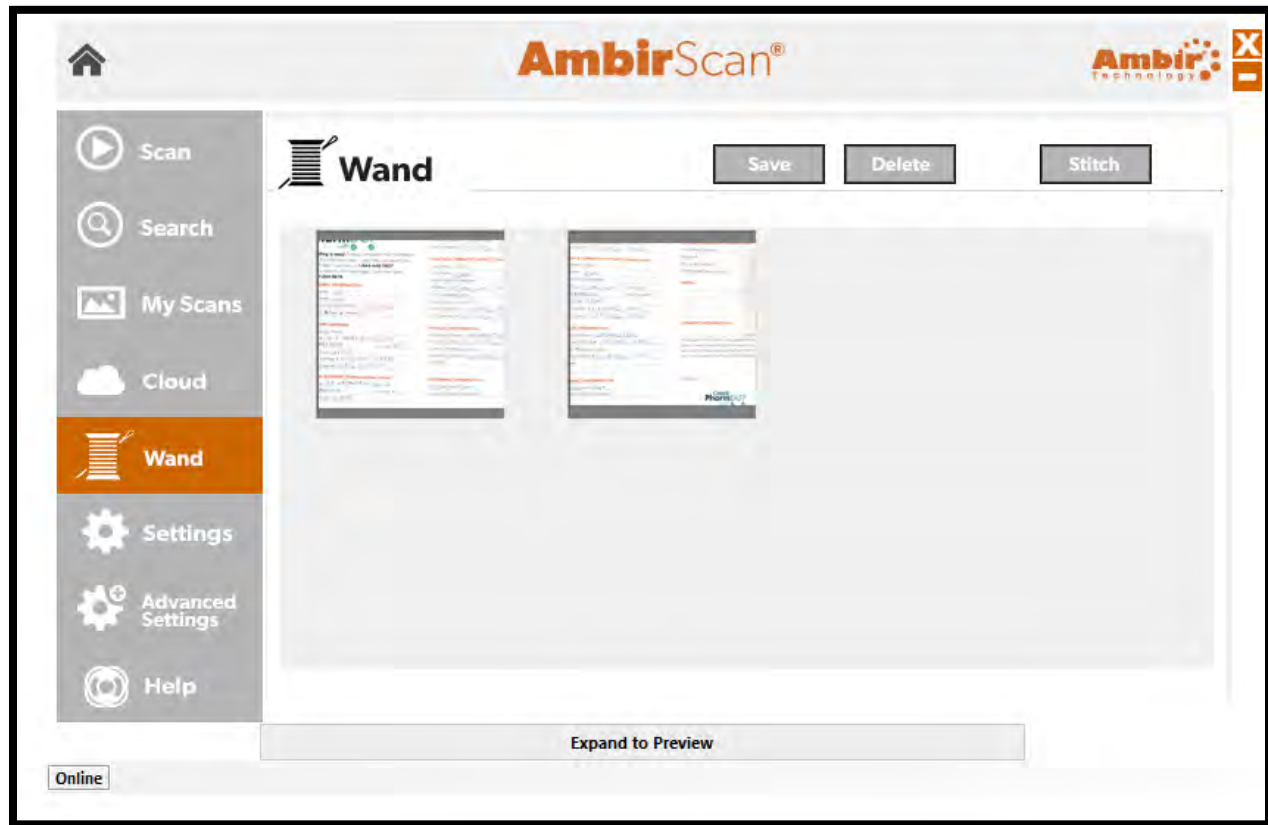

### Save

To save an image, click on the image to select it and hit **Save**. You can select multiple images by **dragging a box** or **holding shift** while selecting images. If saving in PDF, Searchable PDF, Word or Excel format, images will merge into a single file. If saving in JPEG or TIFF format, images will save individually.

### Delete

To delete an image, click on the image and hit **Delete**.

### Stitch

AmbirScan software allows users to combine multiple images into one image, or “stitch” images together. This feature is useful when scanning large images, such as blueprints or posters.

To use the **Stitch** feature in AmbirScan, complete the following steps:

1. Arrange your images to be scanned with at least a **20% overlap** on a flat surface.
2. Using the wand scanner, scan your desired images.
3. Open **AmbirScan**, select the **Wand** tab in the left sided menu.
4. **Drag a box** or **hold shift** while selecting the images you scanned, then select **Stitch**.
5. You will now see the **Stitching** window pop-up. See next section for details.

# TravelScan Pro 300 Handheld Wand Scanner User Guide

## Stitching

Below is a screenshot of the Stitching window. Please see the table below for explanation of the features in the software.

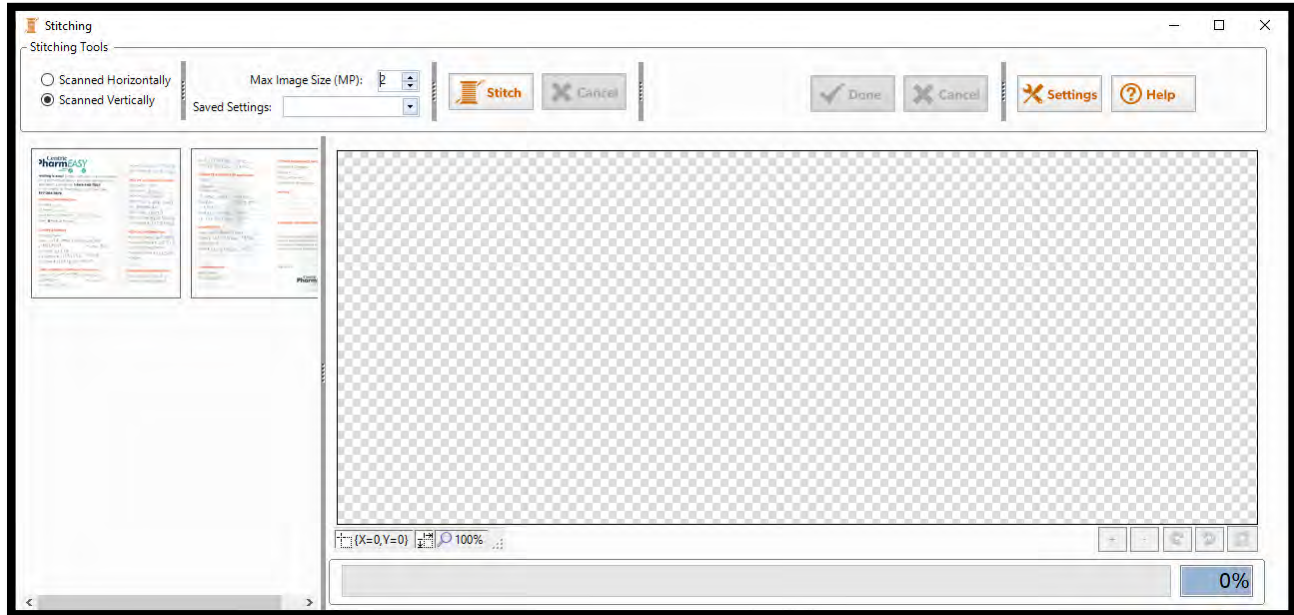

Feature	Description
<b>Scanned Horizontally</b>	Images to stitch were scanned in landscape mode. For more information, see guide below.
<b>Scanned Vertically</b>	Images to stitch were scanned in portrait mode. For more information, see guide below.
<b>Max Image Size (MP)</b>	Set resolution of stitched images.
<b>Saved Settings</b>	Profiles can be set and saved in the Settings section.
<b>Settings</b>	Allows users to adjust Stitch Settings and create Saved Settings profiles.
<b>Help</b>	Provides steps for using Stitching software.

### Scanning Vertically or Horizontally

If you are scanning from the left side of a document to the right side of a document, then you are scanning horizontally. Under Stitching Tools in the top left of the Stitching interface, select **Scanned Horizontally**.

If you are scanning from the top of a document to the bottom of a document, then you are scanning vertically. Under Stitching Tools in the top left of the Stitching interface, select **Scanned Vertically**.



**Scanned Horizontally**



**Scanned Vertically**

# TravelScan Pro 300 Handheld Wand Scanner User Guide

## Using the Settings

Below is a screenshot of the Settings window. Please see the table below for explanation of the features.

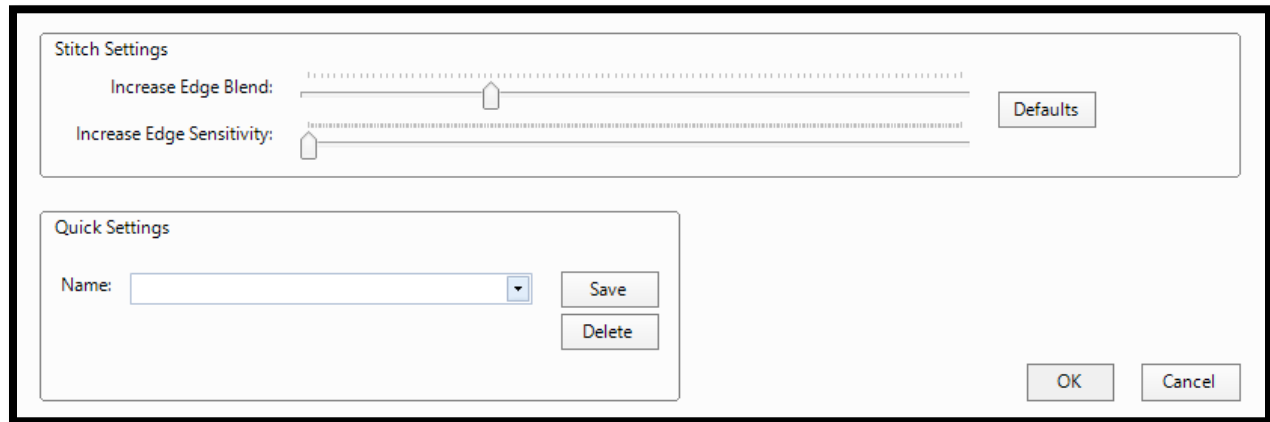

Feature	Description
<b>Increase Edge Blend</b>	Refers to the <a href="#">Gaussian smoothing algorithm</a> that is applied to the stitch. It is most useful when scanning highly detailed images.
<b>Increase Edge Sensitivity</b>	Refers to the <a href="#">Harris Corner Detection algorithm</a> that is applied to the stitch. It is most useful when scanning images that include a lot of lines or text.
<b>Defaults</b>	Resets above settings to the default setting recommend by Ambir for optimal stitch.
<b>Quick Settings</b>	Save and name present Stitch Settings for easy use in future stitches.

**Important:** Ambir does not recommend adjusting the Stitch Settings unless instructed to by Ambir Technical Support or if persistent errors occur while stitching. If adjustments are made, adjust in small increments (10% or less). Click Defaults to get back to default settings.

# TravelScan Pro 300 Handheld Wand Scanner User Guide

## Stitching Images

To Stitch your images, complete the steps below:

1. Review your images and select if they were scanned **vertically or horizontally** in the upper left corner.
2. Arrange your images if needed by **dragging and dropping** in the order you wish to stitch.
3. When your image order ready, select the **Stitch** button.
4. Your Stitched images will display in the main view window.

**Note: Please be patient. The application may take several minutes to stitch the image.**

5. Use can **Zoom, Rotate, and/or Crop** the images as needed using the buttons in the bottom right of the viewing window.
6. When complete, click **Done** to save the Stitched image.
7. You will be prompted to **Tag** the image. If needed, enter a **tag** for the image. If you wish to bypass tagging, click Cancel. Please see the [Tagging](#) section on the following page for more information.

**▲** *The image will be saved using the file naming settings you have selected on the AmbirScan **Scan** tab and in [Settings](#).*

## Scanning With at Least 20% Overlap

To use the Stitch feature successfully, scanned images must have at least **20% overlap** on the border that will be stitched together.

If you are stitching together multiple images, ensure that **20% overlap** is present for all included images on every border that will be stitched.



## Viewing Stitched Files

Your Stitched files are available to view in the **My Scans** left sided menu. To view, **double click** the saved image. You should now see your stitched images.

Images will also save to the folder location specified in the [Settings](#) tab of AmbirScan. To change the default location, navigate to **Settings** and adjust the **Save Path**.

## Tagging

Tagging your scans allows for quick and easy organization using words or terms which are applicable to how you wish to locate your files. This feature is on by default and can be used for Searchable PDF (sPDF), Word, and Excel file types. After completing a scan, a new pop-up window will display after the scan is saved as a file asking you to enter a tag.

For example, if you scan multiple invoice documents, using *Invoice* as a tag will locate all documents with that tagged term in the [Search](#) feature.

After your scan, you will be prompted to enter a tag. See the screenshot below:



Enter the tag you wish to use and click **OK**. To add multiple tags to a file, separate each with a comma (example: Invoice, Test).

If you want to bypass tagging a file, click **Cancel**.

**⚠** *Tagging settings are located in the [Advanced Settings](#) section for the software. Tagging is set to **ON** as a default setting.*

## Search

AmbirScan allows users to search for words, keywords, and tags that are used within their scans. To locate a scan via keyword, simply type the word in the search box and click Search. Use commas to separate multiple keyword searches.

Located keywords will be highlighted in yellow. The file path name will be displayed under the scanned file name.

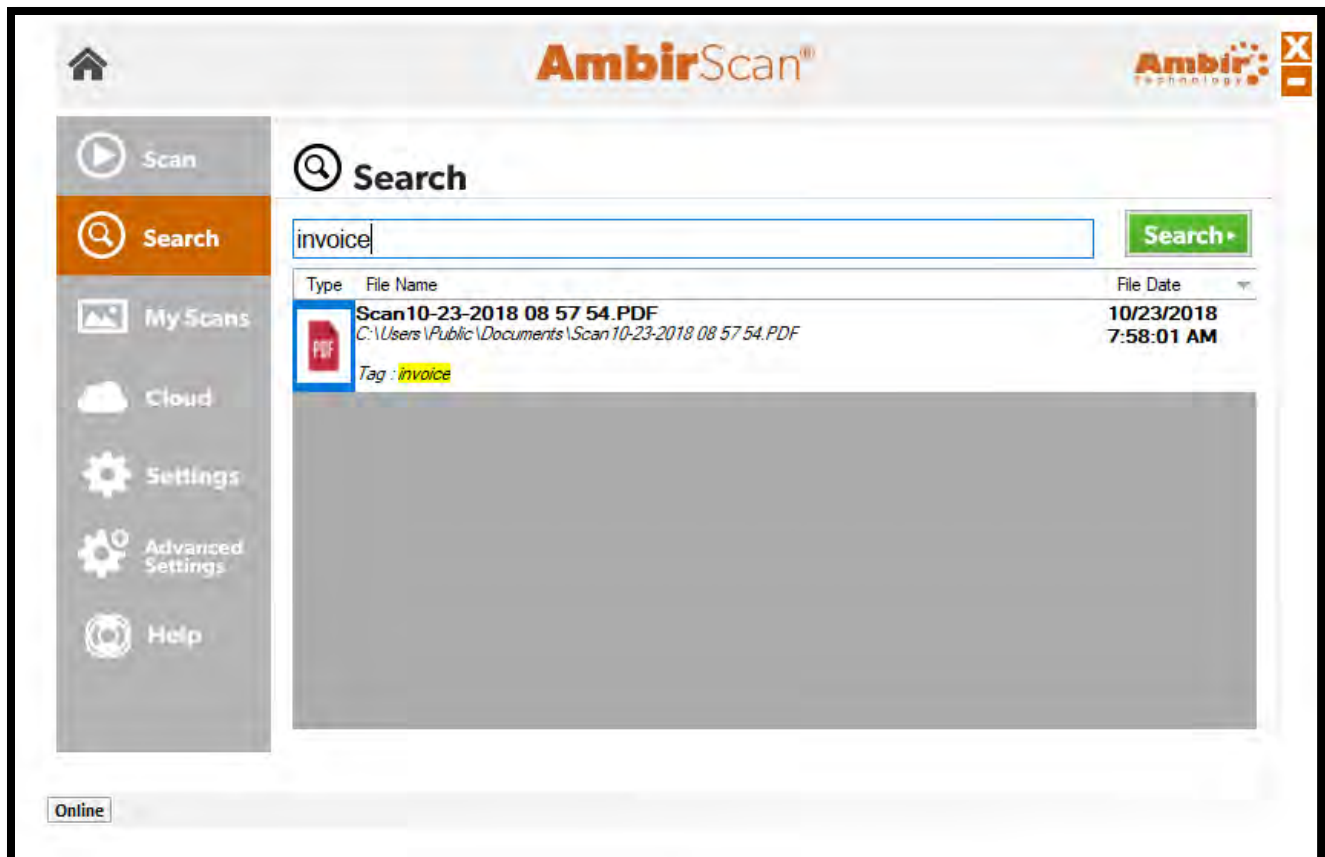

**⚠** Search does **not** search for terms used in file names, only text within the media scanned.



# TravelScan Pro 300 Handheld Wand Scanner User Guide

## My Scans

The My Scans section of AmbirScan displays a list of all saved scans completed with AmbirScan.

There are 3 ways to view the scans: Thumbnail, List, and Detailed List view. The default setting is Detailed List, but this can be changed at any time.

The screenshot below is Detailed List view:

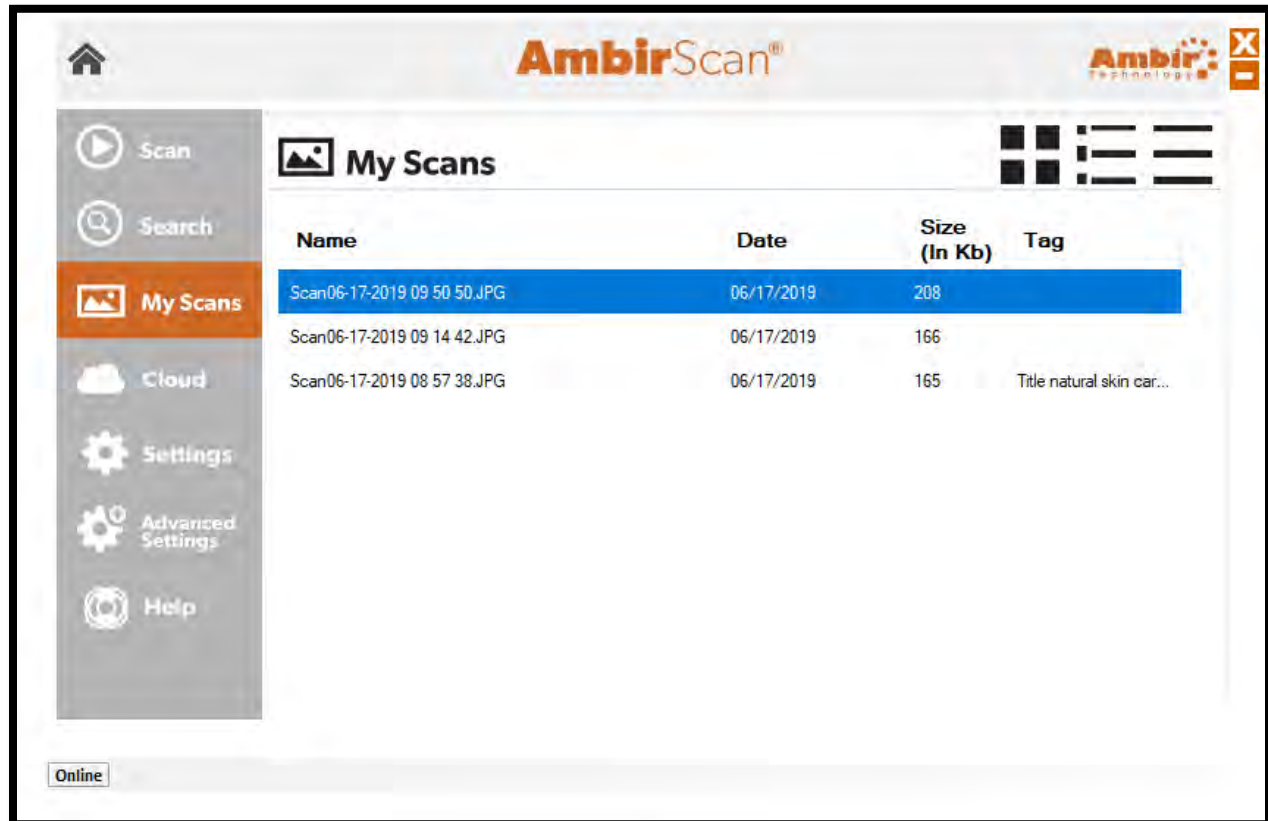

### Viewing

To view a scan in the list, simply double click on the scan.

### Deleting

To delete a scan, right click on the item and select Delete.

### Renaming

You can also rename the scan via the My Scans view. Right click on the scan and select Rename.

### Add/Edit/Delete Tags

If you want to add, edit, or delete a tag, simply double click in Tag field and enter your tag information. For more details on how tagging works, see the [Tagging](#) section of this guide.

# TravelScan Pro 300 Handheld Wand Scanner User Guide

## Cloud

AmbirScan allows users to conveniently save scans to several popular cloud services. Simply drag and drop your file(s) into the appropriate cloud service.

**Note:** The files shown in the Cloud tab are also saved locally to the computer via the saved file path selected in [Settings](#).

The **Your Scans** column will display the files in the Save Path folder specified on the **Settings** menu.

- To add a file to your cloud service, simply drag and drop the file from the **Your Scans** column on to the cloud location.
- To select multiple files, hold the **Ctrl** button and select the files, then drag to the cloud location.

The screenshot below displays the integrated cloud services available:

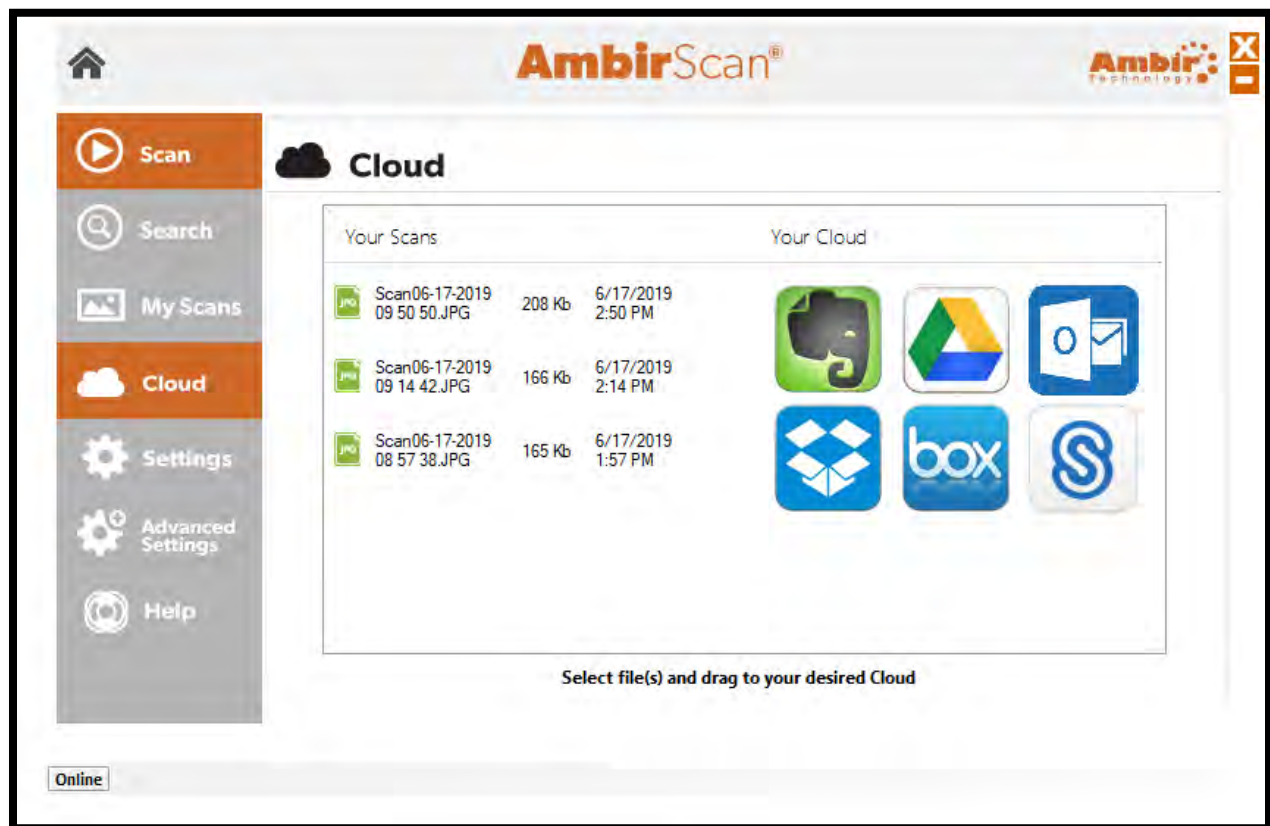

## Settings Menu

The Settings menu is where users can make further adjustments to fit their needs. The below screenshot displays the default settings for options and functions.



See the table on the following page for detailed information on these settings.

**⚠** Please note that settings listed on this screen that are **not** applicable to the TravelScan Pro 300 Handheld Wand Scanner are **not** listed in the table on the following page.

# TravelScan Pro 300 Handheld Wand Scanner User Guide

## Settings Functions

Name	Default (On/Off)	Description
<b>Auto Crop</b>	On	When enabled, AmbirScan crops the image around the scanned item, eliminating empty space.
<b>Start in Auto Scan Mode</b>	On	Allows users to insert card or documents and scan without clicking the Scan button. If deselected, users must manually click Scan to scan cards or documents.
<b>Deskew</b>	On	Corrects any sideways distortion of images resulting from improper scanning.
<b>Auto Rotate</b>	On	Detects improper rotation of documents and corrects. If turned off, images will not be rotated and must be manually adjusted.
<b>Hide on Start-Up</b>	Off	When enabled, AmbirScan runs in the system tray, rather than displaying the user interface upon startup.
<b>Open File After Scanning</b>	Off	When selected, the scan will open in the designated format.
<b>File Naming</b>	On – see description	Options for naming your files once scans are completed. <ul style="list-style-type: none"> <li>• <b>None:</b> Each scan with the same prefix will be over-written by the subsequent scan. Users must change the file name prefix if they wish to preserve new scans.</li> <li>• <b>Date (Default on):</b> Adds a date stamp after the file name you choose.</li> <li>• <b>Numeric:</b> Adds sequential numbers after the file name. <b>Note:</b> sequential numbers are specific to the <b>prefix</b> (examples: Scan1, Scan2, Scan3, Scan 4, etc. Test1, Test2, Test3, Test4, etc.)</li> </ul>
<b>Select a Save Path</b>	On*	The default folder location for saved scans. *Default location: C:\Users\Public\Documents\AmbirScan
<b>File Format</b>	NA	Select between Searchable PDF (sPDF), Word, Excel, PDF, and TIFF.
<b>Scan Size</b>	On – Auto	Default setting is Auto. Other options available depending on your needs.
<b>Scan Profile</b>	On – Color F1	Displays the current profile selected for scanning. The default profile for scanning on installation is Color F1.

## Advanced Settings

The **Advanced Settings** screen houses several other settings for the AmbirScan software. Each of these settings shown are the defaults and may be changed at any time to cater to user preference. See details below for more information on each function.

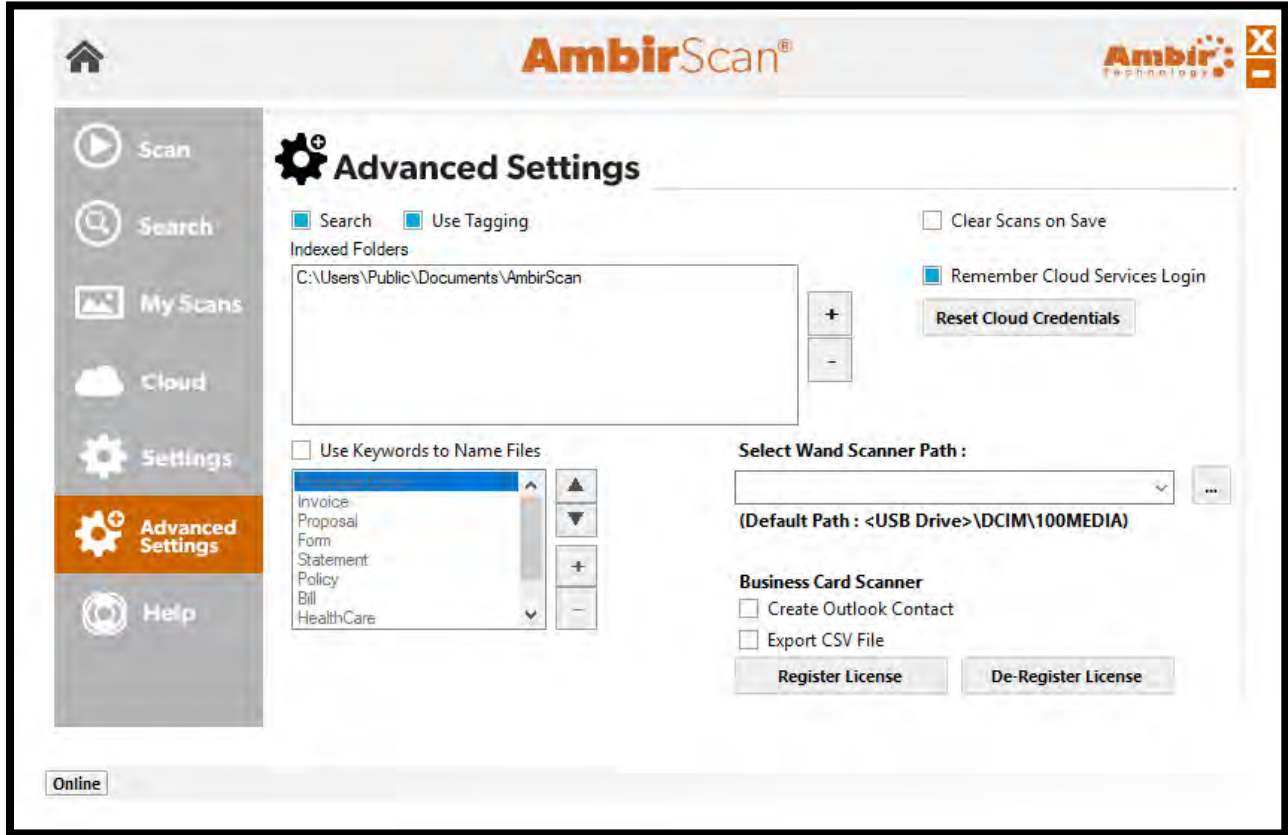

See the table on the following page for detailed information on these settings.

# TravelScan Pro 300 Handheld Wand Scanner User Guide

## Advanced Settings Functions

Name	Default (On/Off)	Description
<b>Search</b>	<b>On</b>	Allows users to search for words in searchable PDF, Word or Excel files saved in the Indexed Folder locations specified. The default location is C:\Users\Public\Documents\AmbirScan. This folder may be changed by clicking the + button and selecting a new folder for addition to the list. As new folders are being indexed the software will display an “Indexing” box in the bottom right of the status bar with moving circle as the files are scanned to be available for future Search actions. To remove a folder from indexing highlight the folder then click the – button and then confirm the action to remove the folder when prompted.
<b>Use Tagging</b>	<b>On</b>	Tagging allows for quick searching and organization of saved media. For more information on using Tags, click <a href="#">here</a> .
<b>Use Keywords to Name Files</b>	<b>Off</b>	Available when creating sPDF, Word, or Excel files. If any of the keywords in this list are included in the file, the keyword will be included in the file name.
<b>Select Wand Scanner Path</b>	<b>On</b>	Change the folder name of your Wand Scanner SD card. The default name is D:\DCIM\100MEDIA. You can access this folder when your scanner is connected via USB to a computer or inserted into a SD card reader slot of a computer.
<b>Remember Cloud Services Login</b>	<b>On</b>	Remembers all cloud service credentials. Turn off if you do not wish to have this information saved.
<b>Reset Cloud Credentials</b>	<b>NA</b>	Removes any saved cloud credentials input.

# TravelScan Pro 300 Handheld Wand Scanner User Guide

## Troubleshooting

The table below lists common issues you may experience with the scanner and software.

Problem	Cause	Solution
Scanner will not power on (battery mode)	<ol style="list-style-type: none"> <li>1. Low battery power</li> <li>2. Batteries not inserted properly</li> </ol>	Replace batteries and/or check batteries are installed correctly.
Pictures cannot be saved on the wand scanner	<ol style="list-style-type: none"> <li>1. Micro SD card has not been installed.</li> <li>2. Memory is full.</li> <li>3. Micro SD card has not been formatted correctly.</li> </ol>	<ol style="list-style-type: none"> <li>1. Install micro SD card.</li> <li>2. Download the pictures from the scanner to the computer to create storage space.</li> <li>3. Reformat your micro SD card. Please refer to <a href="#">Format Setting for SD card</a> section of the guide.</li> </ol>
Stitching is timing out/crashing	The <b>Max Image Size</b> is too high.	Adjust the number down in the <b>Max Image Size</b> window. The default setting is 2.
Stitched image is formatting slightly rotated	The <b>Deskew</b> setting is automatically altering the image.	<ol style="list-style-type: none"> <li>1. Navigate to Settings in AmbirScan.</li> <li>2. On the profile settings, uncheck <b>Deskew</b> and hit Save.</li> </ol>
The darker sections of a stitched image are being cut out	The <b>Auto Crop</b> setting is automatically altering the image.	<ol style="list-style-type: none"> <li>1. Navigate to Settings in AmbirScan.</li> <li>2. On the profile settings, uncheck <b>Auto Crop</b> and hit Save.</li> </ol>

## Technical Support

For assistance with your Ambir product(s), please visit the AmbirScan [Support](#) page on our website. This site contains detailed information, along with helpful FAQs on your product.

Ambir Technical Support is available by phone and chat, Monday – Friday, 8 a.m. – 5 p.m. Central Time, excluding holidays. Phone: (630) 530 – 5400, option 3

Please have your scanner model and serial number available when contacting Support.